









CM 75S4

Prestazioni - Performances - Prestations - Leistungen - Prestaciones						
400 V - 50 Hz			m/1' 	kg	CV	kW
	Sollevamento		4 - 20	3000	15	11
	Hoisting					
	Levage		35	2000		
	Hubwerk					
	Elevación		50	1000		
	Carrello	m/1'	25 - 50		4 - 2	3 - 1.5
	Trolley					
	Chariot					
	Katzfahrwerk					
	Carro					
	Rotazione	g/1'	0 --> 0.3 --> 0.9 INVERTER		5	3.7
	Slewing					
	Orientation					
	Drehwerk					
	Rotación					
	Potenza elettrica necessaria	kVA	20		400 V - 50 Hz	
	Necessary electric power					
	Puissance électrique nécessaire					
	Anschlusswert					
	Potencia electrica necesaria					

Contrappeso in lastre di cemento armato
Lastre en hormigón armado

Contrepoids en plaques de béton armé
Gegenballast aus Stahlbetonplatten

Ferro-concrete ballast slabs

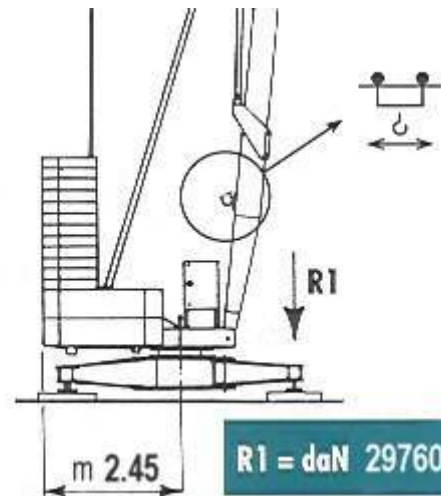

Motore finecorsa **CARRELO**

Engine and limit switch **TROLLEY**

Mateur et fin de courses **CHARIOT**

Motoren und Endschalter **KATZFAHRWERK**

Motore y finales de carrega **CARRO**

Massa gru (con assale da cantiere)

Weight of crane (with yard axle)

Poids de la grue (avec essieu de chantier)

Konstruktionsgewicht del Krans (mit Rangierfahrwerk)

Peso grúa (con eje para obra)

kg 16.100

Massa contrappeso

Counterweight

Contrepoids

Gegengewicht

Contrapeso

kg 24.080

